

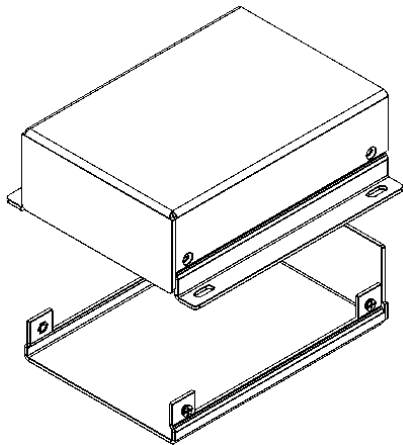

Worldwide OEM equipment supply

CSTM's Aluminum Project Box - DATASHEET

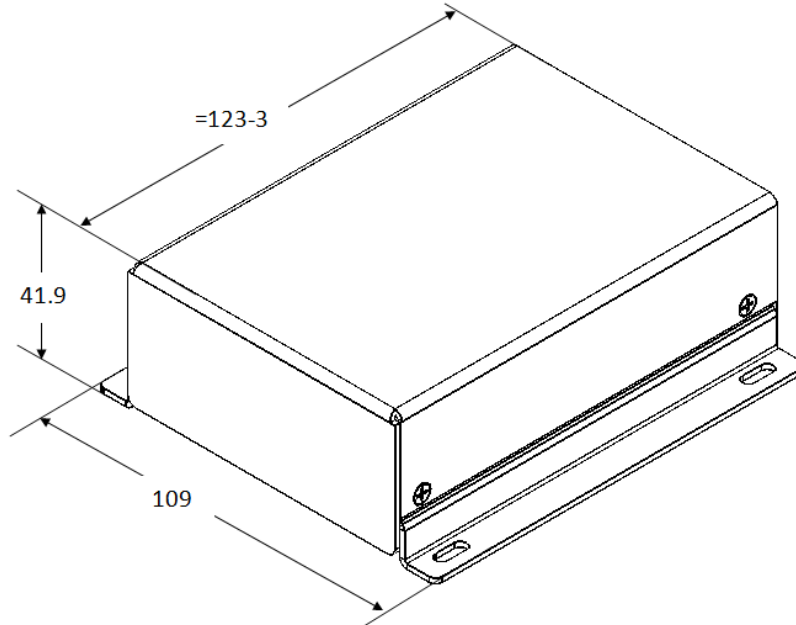

OEMix P/N: CSTM-FR1 - 80X120X36 - P-7035

Elements	Base, Cover and two panels		
Int. Dimensions [mm] (Subtract 4mm for margins)	W	L	H
	80	120	36
Ext. Dimensions [mm]	W	L	H
	109	123	41.9
Finish	a. Conv. coat MIL-C-5541 Class 3 b. Gray paint RAL#7035		
Clamping	4 elongated slots		
Al Sheet thickness [mm]	1.5		

For more information please see www.OEMix.com