

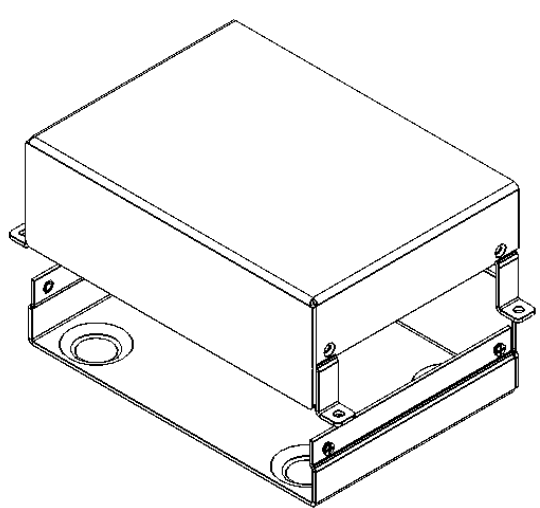

Worldwide OEM equipment supply

CSTM's Aluminum Project Box - DATASHEET

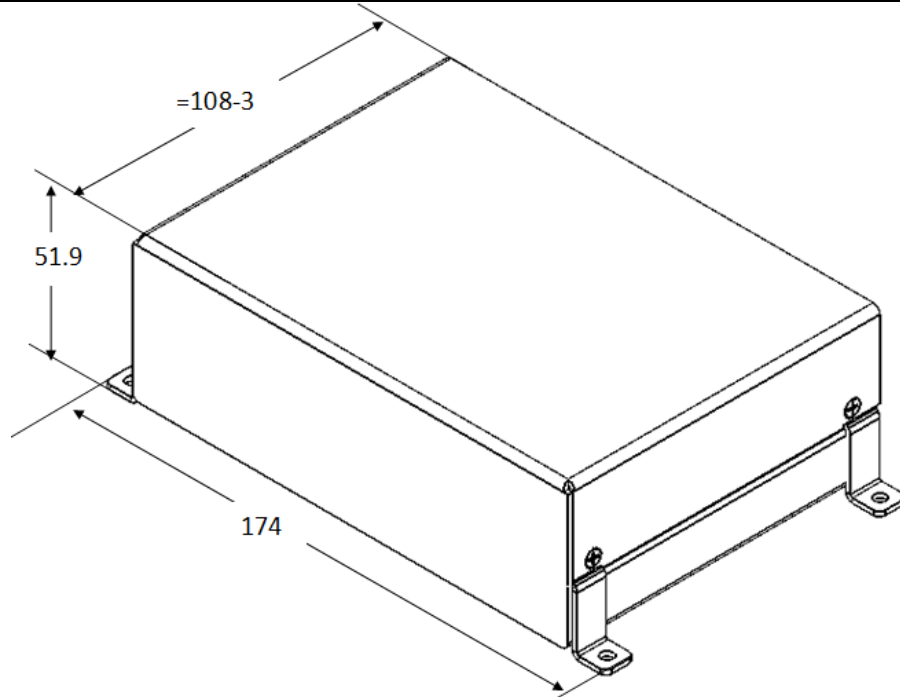

OEMix P/N: CSTM-FRH1 - 145X105X46 - P-7035

| | | | |
|--|--|-----|------|
| Elements | Base, Cover | | |
| Int. Dimensions [mm] (Subtract 4mm for margins) | W | L | H |
| | 145 | 105 | 46 |
| Ext. Dimensions [mm] | W | L | H |
| | 174 | 108 | 51.9 |
| Finish | a. Conv. coat MIL-C-5541 Class 3 b. Gray paint RAL#7035 | | |
| Clamping | 4 anchoring legs w/ screw holes | | |
| Al Sheet thickness [mm] | 1.5 | | |

For more information please see www.OEMix.com