

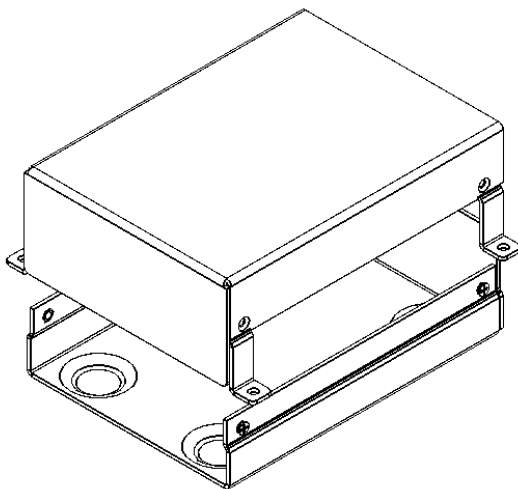

Worldwide OEM equipment supply

CSTM's Aluminum Project Box - DATASHEET

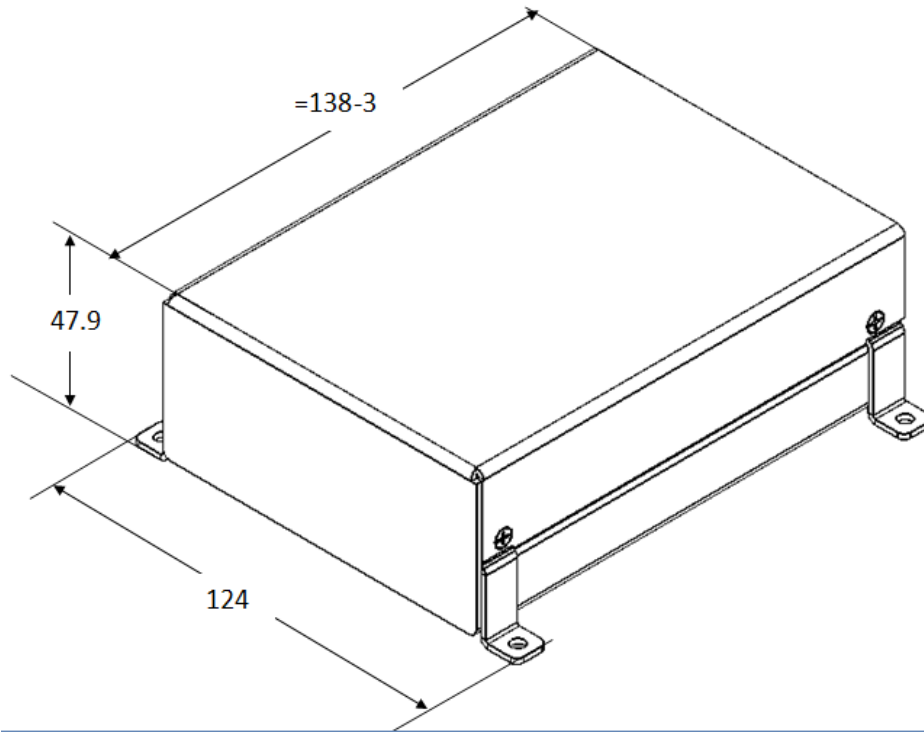

OEMix P/N: CSTM-FRH1 - 95X135X42 - P-7035

Elements	Base, Cover		
Int. Dimensions [mm] (Subtract 4mm for margins)	W	L	H
	95	135	42
Ext. Dimensions [mm]	W	L	H
	124	138	47.9
Finish	a. Conv. coat MIL-C-5541 Class 3 b. Gray paint RAL#7035		
Clamping	4 anchoring legs w/ screw holes		
Al Sheet thickness [mm]	1.5		

For more information please see www.OEMix.com