

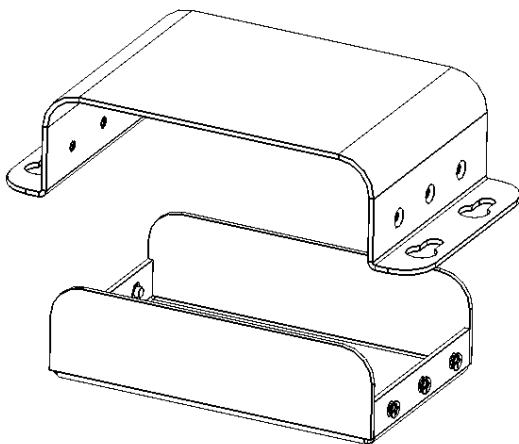

Worldwide OEM equipment supply

**CSTM's Aluminum Project Box - DATASHEET**

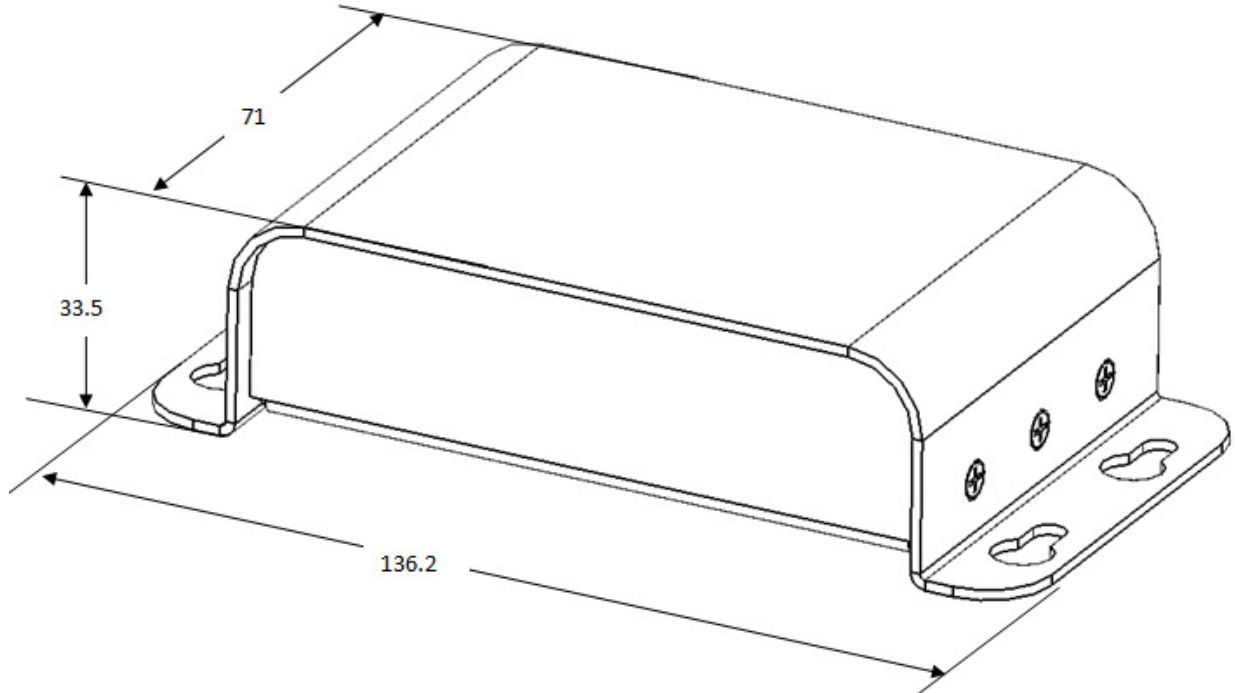

**OEMix P/N: CSTM-FT2 - 100x60x28 - P-7035**

Elements	Base, Cover		
Int. Dimensions [mm] (Subtract 4mm for margins)	W	L	H
	100	60	28
Ext. Dimensions [mm]	W	L	H
	136.2	71	33.5
Finish	a. Conv. coat MIL-C-5541 Class 3 b. Gray paint RAL#7035		
Clamping	4 Keyhole slots		
Al Sheet thickness [mm]	1.5		

For more information please see [www.OEMix.com](http://www.OEMix.com)