

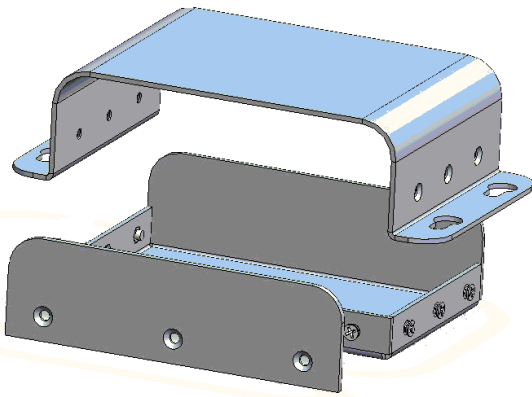

Worldwide OEM equipment supply

CSTM's Aluminum Project Box - DATASHEET

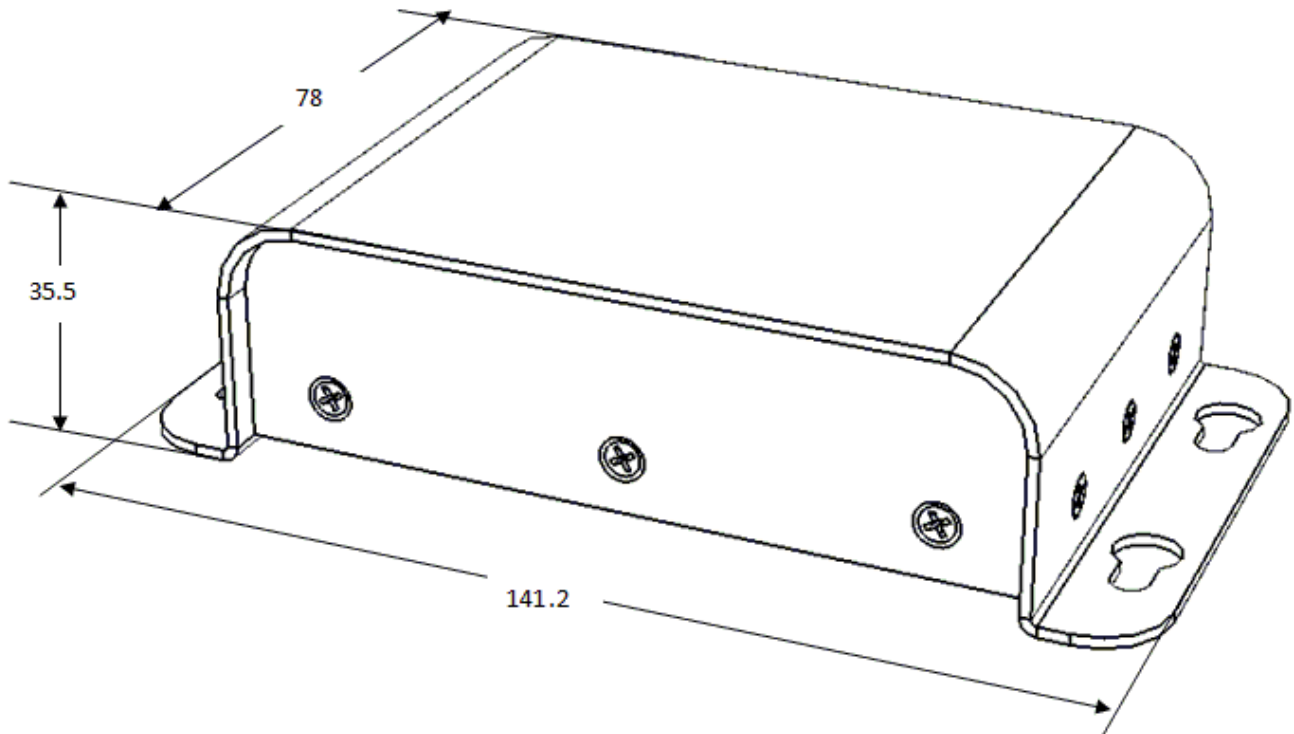

OEMix P/N: CSTM-FT3 - 105x65x30 - P-7035

Elements	Base, Cover, Panel
Int. Dimensions [mm] (Subtract 4mm for margins)	W 105 X L 65 X H30
Ext. Dimensions [mm]	W 141.2 X L 78X H 35.5
Finish	a. Conv. coat MIL-C-5541 Class 3 b. Gray PU paint RAL#7035
Clamping	4 Keyhole slots (panel up)
Al Sheet thickness [mm]	1.5

For more information please see www.OEMix.com