

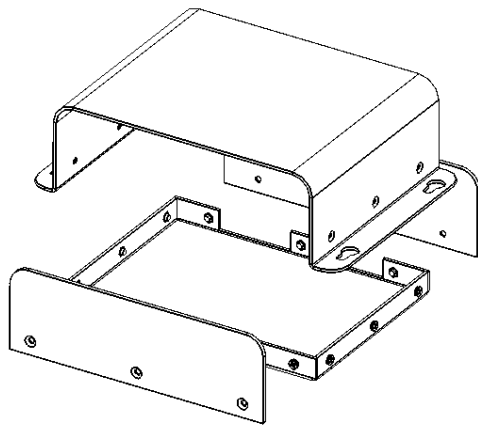

Worldwide OEM equipment supply

**CSTM's Aluminum Project Box - DATASHEET**

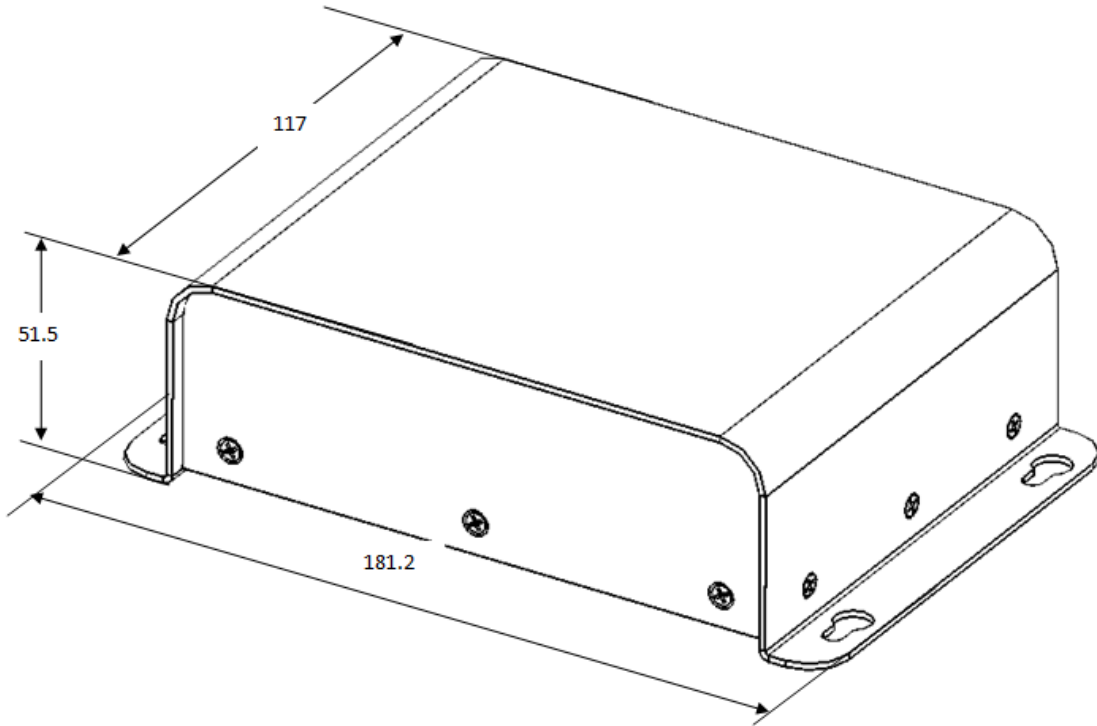

**OEMix P/N: CSTM-FT4 - 145x105x46- P-7035**

Elements	Base, Cover and two panels		
Int. Dimensions [mm] (Subtract 4mm for margins)	W	L	H
	145	105	46
Ext. Dimensions [mm]	W	L	H
	181.2	117	51.5
Finish	a. Conv. coat MIL-C-5541 Class 3 b. Gray paint RAL#7035		
Clamping	4 Keyhole slots		
Al Sheet thickness [mm]	1.5		

For more information please see [www.OEMix.com](http://www.OEMix.com)