

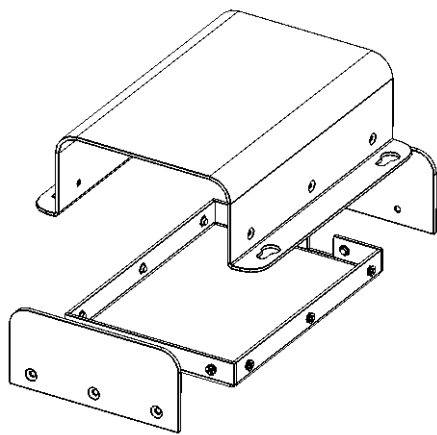

Worldwide OEM equipment supply

CSTM's Aluminum Project Box - DATASHEET

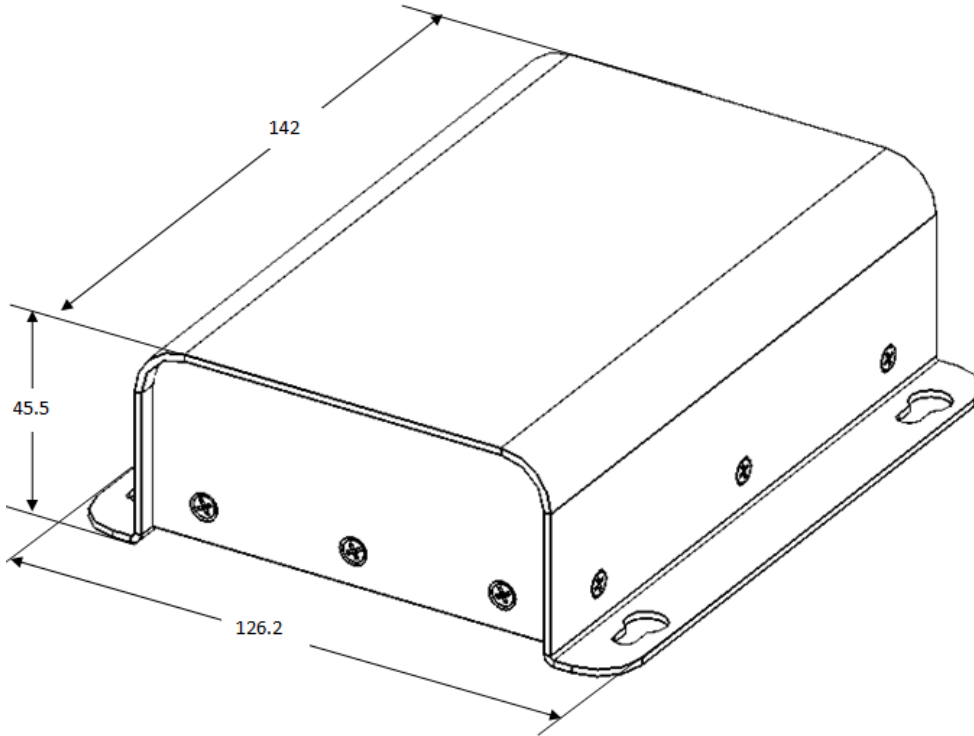

OEMix P/N: CSTM-FT4 - 90x130x40 - P-7035

Elements	Base, Cover and two panels		
Int. Dimensions [mm] (Subtract 4mm for margins)	W	L	H
	90	130	40
Ext. Dimensions [mm]	W	L	H
	126.2	142	45.5
Finish	a. Conv. coat MIL-C-5541 Class 3 b. Gray paint RAL#7035		
Clamping	4 Keyhole slots		
Al Sheet thickness [mm]	1.5		

For more information please see www.OEMix.com