

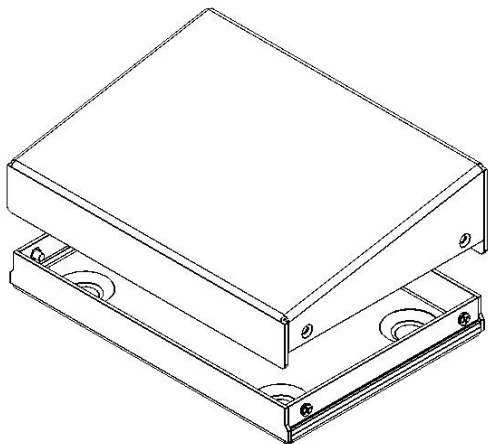

Worldwide OEM equipment supply

**CSTM's Aluminum Project Box - DATASHEET**

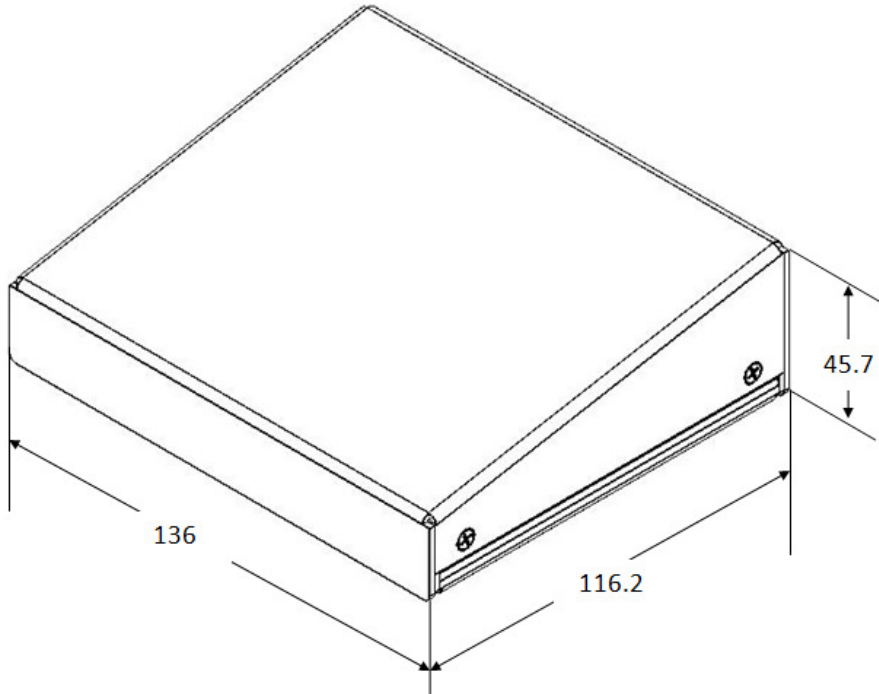

**OEMix P/N: CSTM-INC1 - 140X100X20 - P-7035**

Elements	Base, Cover		
Int. Dimensions [mm] (Subtract 4mm for margins)	<b>W</b>	<b>L</b>	<b>H<sub>MIN</sub></b>
	140	100	19.3
Ext. Dimensions [mm]	<b>W</b>	<b>L</b>	<b>H<sub>MAX</sub></b>
	146	106.2	45.7
Finish	a. Conv. coat MIL-C-5541 Class 3 b. Gray paint RAL#7035		
External Clamping	No t for clamping		
Al Sheet thickness [mm]	1.5		

For more information please see [www.OEMix.com](http://www.OEMix.com)