

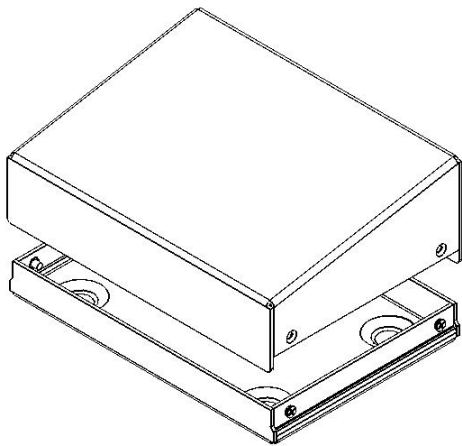

Worldwide OEM equipment supply

CSTM's Aluminum Project Box - DATASHEET

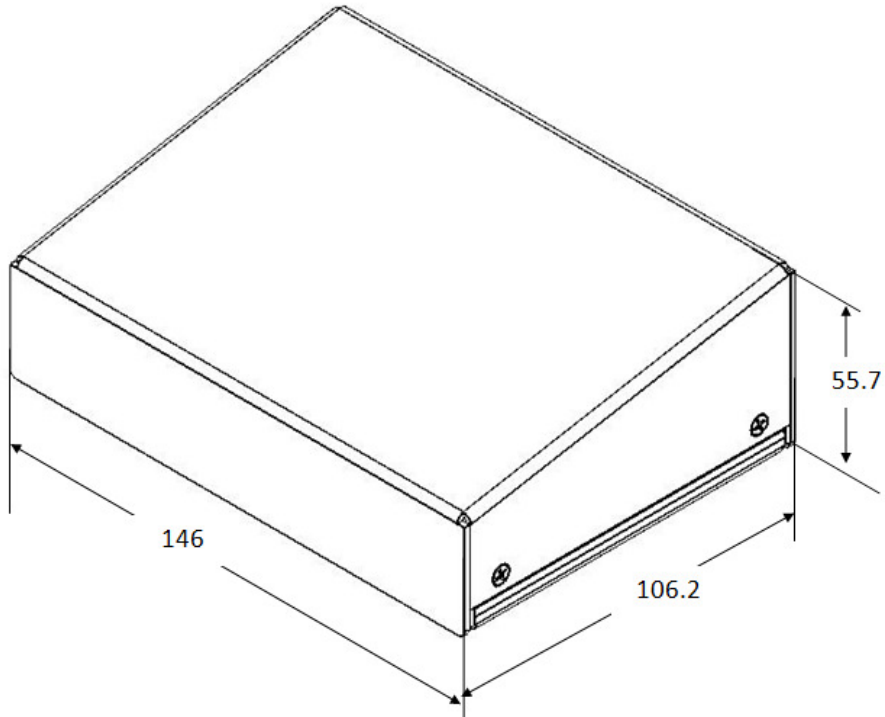

OEMix P/N: CSTM-INC1 - 140X100X30 - P-7035

Elements	Base, Cover		
	Int. Dimensions [mm] (Subtract 4mm for margins)	W 140	L 100
Ext. Dimensions [mm]	W 146	L 106.2	H_{MAX} 55.7
Finish	a. Conv. coat MIL-C-5541 Class 3 b. Gray paint RAL#7035		
External Clamping	No t for clamping		
Al Sheet thickness [mm]	1.5		

For more information please see www.OEMix.com