

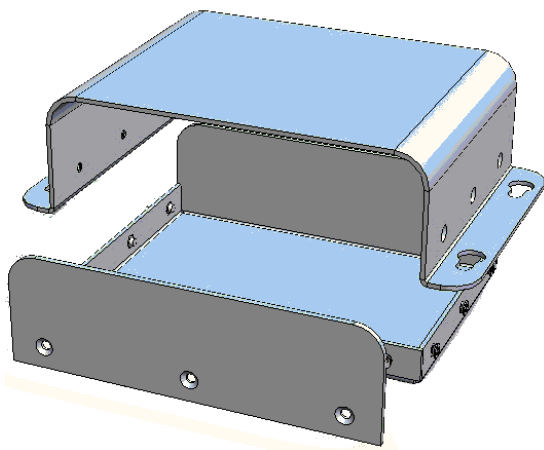

Worldwide OEM equipment supply

**CSTM's Aluminum Project Box - DATASHEET**

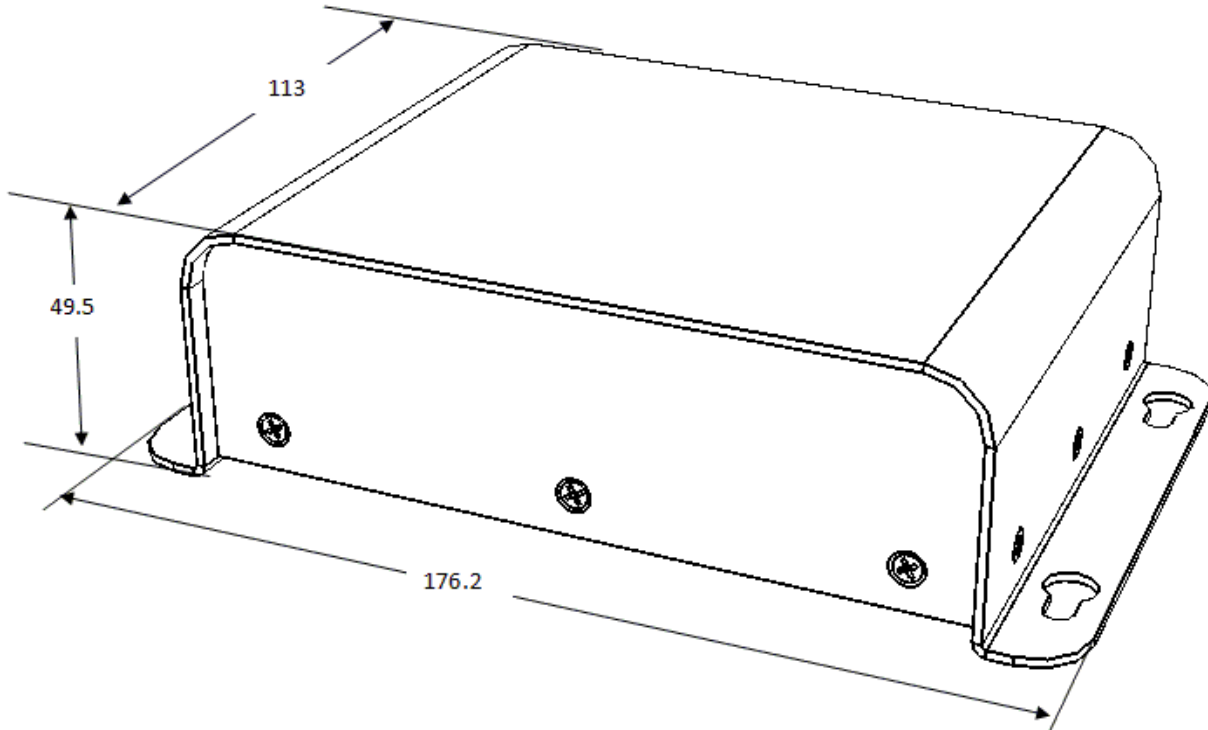

**OEMix P/N: CSTM-FT3 - 140x100x44 - P-7035**

Elements	Base, Cover, Panel
Int. Dimensions [mm] (Subtract 4mm for margins)	W 140 X L 100 X H44
Ext. Dimensions [mm]	W 176.2 X L 113X H 49.5
Finish	a. Conv. coat MIL-C-5541 Class 3 b. Gray PU paint RAL#7035
Clamping	4 Keyhole slots (panel up)
Al Sheet thickness [mm]	1.5

For more information please see [www.OEMix.com](http://www.OEMix.com)